

Geometric Objects and Transformation

514780
2018년 가을학기
10/11/2018
단국대학교 박경신

RHS Coordinate Systems

- Right Hand Coordinate System (RHS) – z+ coming out of the screen
- Counter clockwise rotation
- If X-axis rotation, Y->Z rotation is positive
- If Y-axis rotation, Z->X rotation is positive
- If Z-axis rotation, X->Y rotation is positive

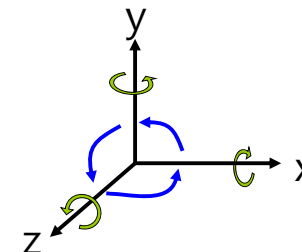

Matrix Operations

- OpenGL Matrix
 - 4x4 행렬 M의 element는 열-중심 (column-major) 순서로 지정해야 한다.

$$p' = M * p = \begin{pmatrix} m_0 & m_4 & m_8 & m_{12} \\ m_1 & m_5 & m_9 & m_{13} \\ m_2 & m_6 & m_{10} & m_{14} \\ m_3 & m_7 & m_{11} & m_{15} \end{pmatrix} \begin{pmatrix} v_0 \\ v_1 \\ v_2 \\ v_3 \end{pmatrix}$$

Translation

- Translation
 - 이동변환 인자 dx, dy, dz는 실수
 - 2차원 이동 : dz = 0.0
- ```
glm::mat4 T = glm::translate(glm::mat4(1.0f), glm::vec3(0.5f, -0.2f, 0));
```

$$p' = Tp \quad T = \begin{bmatrix} 1 & 0 & 0 & dx \\ 0 & 1 & 0 & dy \\ 0 & 0 & 1 & dz \\ 0 & 0 & 0 & 1 \end{bmatrix}$$

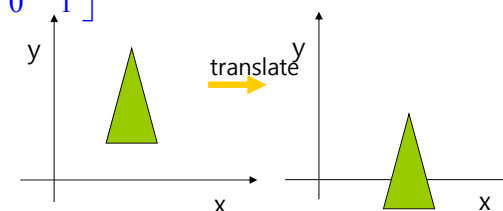

## Rotation

### □ Rotation

- 임의의 축 axis (x,y,z)에 대해 각도 angle (OpenGL은 degree 사용)만큼 회전
- 2차원 회전은 z-축 (0, 0, 1)로 사용한다.

`glm::mat4 Rx = glm::rotate(glm::mat4(1.0f), 30.0f, glm::vec3(1, 0, 0));`

`glm::mat4 Ry = glm::rotate(glm::mat4(1.0f), 60.0f, glm::vec3(0, 1, 0));`

`glm::mat4 Rz = glm::rotate(glm::mat4(1.0f), 45.0f, glm::vec3(0, 0, 1));`

`glm::mat4 Ra = glm::rotate(glm::mat4(1.0f), 45.0f, glm::vec3(1, 1, 1));`

## Rotation

$$p' = R_x p \quad R_x = \begin{bmatrix} 1 & 0 & 0 & 0 \\ 0 & \cos \theta & -\sin \theta & 0 \\ 0 & \sin \theta & \cos \theta & 0 \\ 0 & 0 & 0 & 1 \end{bmatrix}$$

$$p' = R_y p \quad R_y = \begin{bmatrix} \cos \theta & 0 & \sin \theta & 0 \\ 0 & 1 & 0 & 0 \\ -\sin \theta & 0 & \cos \theta & 0 \\ 0 & 0 & 0 & 1 \end{bmatrix}$$

$$p' = R_z p \quad R_z = \begin{bmatrix} \cos \theta & -\sin \theta & 0 & 0 \\ \sin \theta & \cos \theta & 0 & 0 \\ 0 & 0 & 1 & 0 \\ 0 & 0 & 0 & 1 \end{bmatrix}$$

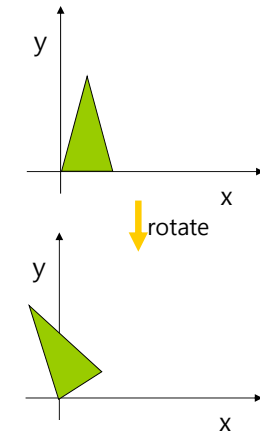

## Scale

### □ Scale

- x-축으로  $s_x$ 만큼, y-축으로  $s_y$ 만큼, z-축으로  $s_z$ 만큼 크기를 변환
- 이 때, scale factor > 1이면 커지고,  $0 < \text{scale factor} \leq 1$ 이면 작아지고, scale factor < 0면 반사(reflection)
- 2차원 크기변환은 z에 1을 넣는다.

`glm::mat4 S = glm::scale(glm::mat4(1.0f), glm::vec3(0.25f, 0.5f, 1.0f));`

$$p' = S p \quad S = \begin{bmatrix} s_x & 0 & 0 & 0 \\ 0 & s_y & 0 & 0 \\ 0 & 0 & s_z & 0 \\ 0 & 0 & 0 & 1 \end{bmatrix}$$

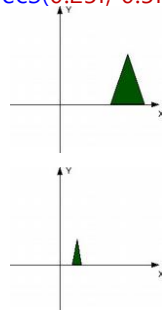

## Transformation Order

- OpenGL에서 모델링 변환 행렬들은 객체에 설정된 반대 순서로 적용된다.

- 즉, 마지막 변환 (즉, 기하 함수 호출 바로 전에 쓰인 것)이 정점 데이터에 먼저 적용된다.

`glm::mat4 Tx = glm::translate(glm::mat4(1.0f), glm::vec3(0.5, 0, 0));`  
`glm::mat4 Rz = glm::rotate(glm::mat4(1.0f), 45, glm::vec3(0, 0, 1));`

`glm::mat4 TR = Tx * Rz; // rotate 먼저, translate 나중` M = T \* R  
`drawTriangle(TR);` p' = M \* p

`glm::mat4 RT = Rz * Tx; // translate 먼저, rotate 나중`  
`drawTriangle(RT);` M = R \* T  
p' = M \* p

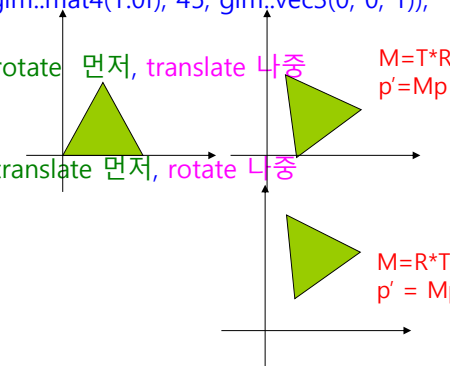

## Transformation Order

```
glm::mat4 T = glm::translate(glm::mat4(1.0f), glm::vec3(1.5f, 0.0f, 0.0f));
glm::mat4 R = glm::rotate(glm::mat4(1.0f), 45.0f, glm::vec3(0.0f, 0.0f, 1.0f));
glm::mat4 S = glm::scale(glm::mat4(1.0f), glm::vec3(0.5f, 0.7f, 1.0f));
```

```
drawCube();
```

```
glm::mat4 RT = R * T; // p' = R * T * p (red)
drawCube();
```

```
glm::mat4 TR = T * R; // p' = T * R * p (green)
drawCube();
```

```
glm::mat4 TRS = T * R * S; // p' = T * R * S * p (blue)
drawCube();
```

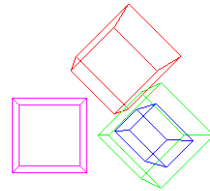

## Hierarchical Transformations

- 계층적 변환 (hierarchical transformation)은 한 변환을 다른 변환에 소속시키는 것으로 생각하면 된다.
- 계층적 변환이란 한 객체의 변환을 다른 객체들에 상대적인 변환으로 사용된다.
- 2개의 자동차 바퀴(wheel)가 자동차 차체(body)에 상대적인 계층적 변환의 예를 보자면:

- Apply body transformation
- Draw body
- Save state
- Apply front wheel transformation
- Draw wheel
- Restore saved state
- Apply rear wheel transformation
- Draw wheel

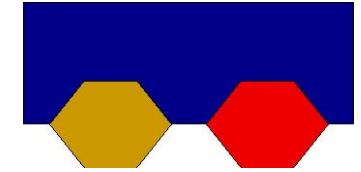

## Hierarchical Transformations

- 또한, 이 자동차가 움직이게 되면, 자동차의 차체에서 상대적인 위치에 있는 바퀴 두 개도 역시 몸체와 같이 움직이게 됨을 알 수 있다.
- 이 때, 두 개의 바퀴를 자동차의 몸체의 변환에 같이 영향을 받도록 만들어 하며, 바퀴가 각자 따로 변환하지 않도록 한다.

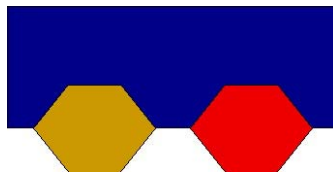

## Example: Car

```
bodyTransform = glm::translate(glm::mat4(1.0f), position); // car position
wheelMatrix = MVP * bodyTransform;
body.draw();
wheelTransform[0] = glm::translate(glm::mat4(1.0f), glm::vec3(-0.5f, 0.0f, -0.5f)) *
 glm::rotate(glm::mat4(1.0f), angle, glm::vec3(0.0f, 0.0f, 1.0f));
wheelMatrix = MVP * bodyTransform * wheelTransform[0];
wheel.draw();
wheelTransform[1] = glm::translate(glm::mat4(1.0f), glm::vec3(-0.5f, 0.0f, 0.5f)) *
 glm::rotate(glm::mat4(1.0f), angle, glm::vec3(0.0f, 0.0f, 1.0f));
wheelMatrix = MVP * bodyTransform * wheelTransform[1];
wheel.draw();
wheelTransform[2] = glm::translate(glm::mat4(1.0f), glm::vec3(0.5f, 0.0f, -0.5f)) *
 glm::rotate(glm::mat4(1.0f), angle, glm::vec3(0.0f, 0.0f, 1.0f));
wheelMatrix = MVP * bodyTransform * wheelTransform[2];
wheel.draw();
wheelTransform[3] = glm::translate(glm::mat4(1.0f), glm::vec3(0.5f, 0.0f, 0.5f)) *
 glm::rotate(glm::mat4(1.0f), angle, glm::vec3(0.0f, 0.0f, 1.0f));
wheelMatrix = MVP * bodyTransform * wheelTransform[3];
wheel.draw();
```

## Transformation Hierarchy

- 계층적 변환 (hierarchical transformations)은 종종 변환의 트리 (tree) 구조로 표현한다.
- 3차원 캐릭터를 디자인하기 위해 강체 부분 (rigid body parts)으로 만들어진 계층적 변환 구조를 사용한다.
- 그리고, 보다 유연한 3차원 캐릭터 디자인을 위해서는 다수의 계층적 변환을 적절히 섞어 사용해야 한다.
- 이런 계층은 장면그래프 (scene graph)의 기초와 동일하다.

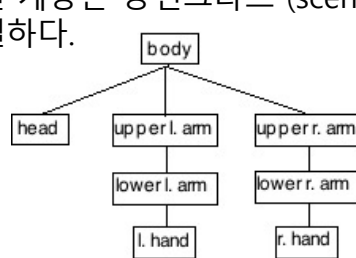

## Example: Robot

```

void SimpleRobot::draw(glm::mat4 MVP)
{
 // base
 glm::mat4 baseMatrix =
 MVP * baseTransform;
 base.draw();

 // lowerArm
 glm::mat4 lowerArmMatrix =
 MVP * baseTransform * lowerArmTransform;
 arm.draw();

 // upperArm
 glm::mat4 upperArmMatrix =
 MVP * baseTransform * lowerArmTransform * upperArmTransform;
 arm.draw();
}

```

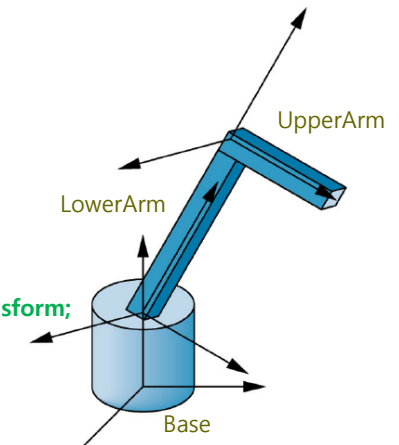

## Example: Robot

```

SimpleRobot::SimpleRobot(Program* p_) {
 theta = 0.0f; phi = 0.0f; psi = 0.0f; // base, lower/upper arm rotation
 base = Cylinder(2.0f, 3.0f, 16);
 arm = Parallelepiped(glm::vec3(-0.25f, 0.0f, -0.25f), glm::vec3(0.5f, 0.0f, 0.0f), glm::vec3(0.0f, 0.0f, 0.5f), glm::vec3(0.0f, 3.0f, 0.0f));
}

bool SimpleRobot::update(float deltaTime) {
 baseTransform = glm::translate(glm::mat4(1.0f), glm::vec3(0.0f, -1.5f, 0.0f)) * glm::rotate(glm::mat4(1.0f), theta, glm::vec3(0.0f, 1.0f, 0.0f));
 lowerArmTransform = glm::translate(glm::mat4(1.0f), glm::vec3(0.0f, 1.5f, 0.0f)) * glm::rotate(glm::mat4(1.0f), phi, glm::vec3(0.0f, 0.0f, 1.0f));
 upperArmTransform = glm::translate(glm::mat4(1.0f), glm::vec3(0.0f, 3.0f, 0.0f)) * glm::scale(glm::mat4(1.0f), glm::vec3(1.0f, 0.5f, 1.0f)) * glm::rotate(glm::mat4(1.0f), psi, glm::vec3(0.0f, 0.0f, 1.0f));
 return true;
}

```

## Example: Solar

```

const float SimpleSolar::SunRadius = 4.0f;
const float SimpleSolar::EarthRadius = 1.0f;
const float SimpleSolar::MoonRadius = 0.5f;
const float SimpleSolar::EarthDistanceFromSun = 10.0f;
const float SimpleSolar::MoonDistanceFromEarth = 2.0f;

SimpleSolar::SimpleSolar(Program* p_)
{
 p = p_;
 sunSpin = 0.0f; // sun spin
 earthSpin = 0.0f; // earth spin
 earthOrbit = 0.0f; // earth orbit around the sun
 moonSpin = 0.0f; // moon spin
 moonOrbit = 0.0f; // moon orbit around the earth
 sun = Sphere(SunRadius, 16, 16);
 earth = Sphere(EarthRadius, 16, 16);
 moon = Sphere(MoonRadius, 16, 16);
}

```

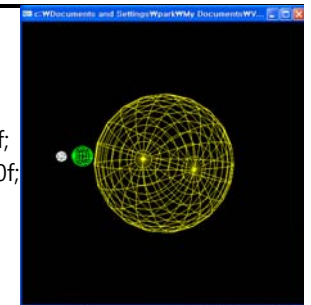

## Example: Solar

```
bool SimpleSolar::update(float deltaTime)
{
 // The Sun spins by rotating it about y-axis
 sunSpin += (float) (deltaTime) * 0.01f;
 sunTransform = glm::rotate(glm::mat4(1.0f), sunSpin, glm::vec3(0.0f, 1.0f, 0.0f));

 // The Earth spins on its own axis and orbits the Sun
 earthSpin += (float) (deltaTime) * 0.05f;
 earthOrbit += (float) (deltaTime) * 0.01f;
 earthTransform = glm::rotate(glm::mat4(1.0f), earthOrbit, glm::vec3(0.0f, 1.0f, 0.0f))
 * glm::translate(glm::mat4(1.0f), glm::vec3(0.0f, 0.0f, EarthDistanceFromSun))
 * glm::rotate(glm::mat4(1.0f), earthSpin, glm::vec3(0.0f, 1.0f, 0.0f));
}
```

## Example: Solar

```
// The Moon spins on its own axis and orbits the Earth (that orbits the Sun)
moonSpin += (float) (deltaTime) * 0.07f;
moonOrbit += (float) (deltaTime) * 0.08f;
moonTransform = glm::rotate(glm::mat4(1.0f), earthOrbit, glm::vec3(0.0f, 1.0f, 0.0f))
 * glm::translate(glm::mat4(1.0f), glm::vec3(0.0f, 0.0f, EarthDistanceFromSun))
 * glm::rotate(glm::mat4(1.0f), moonOrbit, glm::vec3(0.0f, 1.0f, 0.0f))
 * glm::translate(glm::mat4(1.0f), glm::vec3(0.0f, 0.0f, MoonDistanceFromEarth))
 * glm::rotate(glm::mat4(1.0f), moonSpin, glm::vec3(0.0f, 1.0f, 0.0f));

return true;
}
```

## Example: Solar

```
void SimpleSolar::draw(glm::mat4 MVP) {
 glm::mat4 sunMatrix = MVP * sunTransform;
 p->useProgram();
 p->setUniform("gMVP", sunMatrix);
 glVertexAttrib3f(1, 1, 1, 0); // yellow - sun
 sun.draw();
 glm::mat4 earthMatrix = MVP * earthTransform;
 p->useProgram();
 p->setUniform("gMVP", earthMatrix);
 glVertexAttrib3f(1, 0, 1, 0); // green - earth
 earth.draw();
 glm::mat4 moonMatrix = MVP * moonTransform;
 p->useProgram();
 p->setUniform("gMVP", moonMatrix);
 glVertexAttrib3f(1, 0.5, 0.5, 0.5); // gray - moon
 moon.draw();
}
```

## Modeling a Cube

- OpenGL에서 정점의 winding 순서  $\{v_0, v_3, v_2, v_1\}$ 과  $\{v_1, v_0, v_3, v_2\}$ 은 같은 다각형을 만들어낸다. 그러나, 정점의 winding 순서  $\{v_1, v_2, v_3, v_0\}$ 은 다르다.
- OpenGL에서는 오른손 좌표계를 사용하므로, counter-clockwise encirclement로 정점을 정의했을 때 바깥쪽을 향하는 법선벡터 (normal)을 만들어낸다.

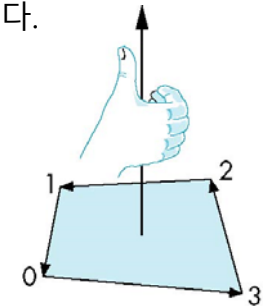

## Modeling a Cube

- Vertex list와 Index list를 사용하여 cube를 그린다.

```
GLfloat cubeVertices[][3] = {
 {-1.0,-1.0,-1.0}, { 1.0,-1.0,-1.0},
 { 1.0, 1.0,-1.0}, {-1.0, 1.0,-1.0},
 {-1.0,-1.0, 1.0}, { 1.0,-1.0, 1.0},
 { 1.0, 1.0, 1.0}, {-1.0, 1.0, 1.0}
};
```

```
GLfloat cubeNormals[][3] = {
 { 0.0, 0.0, 1.0}, // front
 { 0.0, 0.0, -1.0}, // back
 {-1.0, 0.0, 0.0}, // left
 { 1.0, 0.0, 0.0}, // right
 { 0.0, 1.0, 0.0}, // top
 { 0.0, -1.0, 0.0}, // bottom
};
```

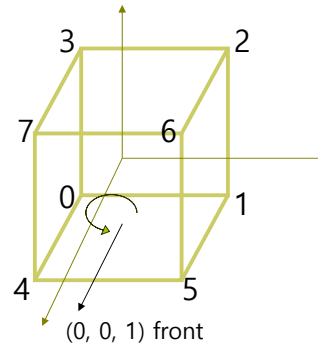

## Modeling a Cube

```
GLint cubeIndices[] = {
 4, 5, 6, 4, 6, 7, // front
 1, 0, 3, 1, 3, 2, // back
 0, 4, 7, 0, 7, 3, // left
 5, 1, 2, 5, 2, 6, // right
 7, 6, 2, 7, 2, 3, // top
 0, 1, 5, 0, 5, 4 // bottom
};
```

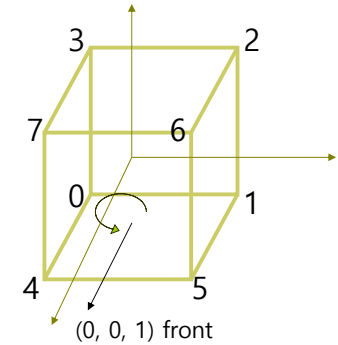

## Model Files

- 3차원 모델 종류
  - Wavefront (.obj)
  - Inventor (.iv)
  - VRML / X3D
  - 3D Studio (.3ds)
  - OpenFlight (.flt)
  - ...
- 3차원 객체 모델은 아래와 같은 정보를 포함하고 있다.
  - Geometry data – vertex positions, faces
  - Colors/material properties
  - Textures
  - Transformations

## Wavefront OBJ Files

- OBJ file은 일반 텍스트 파일로, 정점 (vertices), 다각형 표면 (polygon faces), 재질 (material) 등 그 외 다수의 정보를 포함하고 있다.
- 각 line은 정점, 법선벡터, 텍스처 등 어떤 정보를 가진 line인지 알려주는 토큰 (token)으로 시작한다.
  - v *x y z*
    - Vertex position
  - vn *x y z*
    - Vertex normal
  - vt *u v*
    - texture coordinate
  - f *v1 v2 v3 ..*
    - Face (list of vertex numbers)
  - Mtllib *file.mtl*
    - File containing material descriptions
  - Usemtl *name*
    - Current material to apply to geometry